



SANYO Semiconductors
DATA SHEET

LA42352 — **Monolithic Linear IC**
5W 2-Channel AF Power Amplifier
With DC Volume Control

Overview

LA42352 is 5W 2-channel AF power amplifier with DC volume control intended for televisions.

LA42000 series is power IC which made Pin compatible possible altogether in 3 to 15W. They consist of four kinds of power ICs. (mono, stereo, mono with volume function, stereo with volume function.). They realized PCB layout communalization of an audio power block of TV.

	PO	Channel		Volume
		Mono	Stereo	
LA42051	5W	○		
LA42052	5W		○	
LA42351	5W	○		○
LA42352	5W		○	○
LA42071	7W	○		
LA42072	7W		○	
LA42152	15W		○	

Feature

- PO 5W×2ch (VCC = 18V, R_L = 8Ω, THD = 10%)
- Built-in DC Volume Control.
- Built-in Standby function.
- Built-in overheat protection.

- Any and all SANYO products described or contained herein do not have specifications that can handle applications that require extremely high levels of reliability, such as life-support systems, aircraft's control systems, or other applications whose failure can be reasonably expected to result in serious physical and/or material damage. Consult with your SANYO representative nearest you before using any SANYO products described or contained herein in such applications.
- SANYO assumes no responsibility for equipment failures that result from using products at values that exceed, even momentarily, rated values (such as maximum ratings, operating condition ranges, or other parameters) listed in products specifications of any and all SANYO products described or contained herein.

Specifications

Maximum Ratings at Ta = 25 °C

Parameter	Symbol	Conditions	Ratings	Unit
Maximum supply voltage	V _{CC} max	No signal	24	V
Allowable power dissipation	P _d max	Infinite heat sink	15	W
Maximum junction temperature	T _j max		150	°C
Thermal resistance	θ _{jc}		3	°C/W
Operating temperature	Topr		-25 to +75	°C
Storage temperature	Tstg		-40 to +150	°C

Operating Conditions at Ta = 25 °C

Parameter	Symbol	Conditions	Ratings	Unit
Recommended supply voltage	V _{CC}		18	V
Recommended load resistance	R _L		8	Ω
Allowable operating voltage range	V _{CC} op		10 to 22	V

Operating Characteristics at Ta = 25°C, V_{CC} = 18V, R_L = 8Ω, Volume = 5V, f = 1kHz, R_g = 600Ω

Parameter	Symbol	Conditions	Ratings			Unit
			min	typ	max	
Standby current	I _{STB}	Amplifier off		1	10	μA
Quiescent current	I _{CCO}	R _g = 0, Volume = 0V	35	65	130	mA
Output power	P _O	THD = 10%	4	5		W
Total harmonic distortion	THD	P _O = 1W		0.1	0.8	%
Voltage gain	VG	V _O = 0dBm	32.5	34.5	36.5	dB
Output noise voltage	V _{NO}	R _g = 0, Volume = 0V, BPF = 20Hz to 20kHz		0.13	0.4	mVrms
Volume Attenuation	Att	V _{IN} = 100mV, V _{cont} = 0V, with 1k-BPF	70	80		dB
Channel separation	Sep.	R _g = 10kΩ, V _O = 0dBm	48	55		dB
Standby control voltage (The Pin 5 voltage)	V _{STB-H}	Amplifier on	2.5		10	V
	V _{STB-L}	Amplifier off	0		0.5	V
Input resistance	R _i		14	20	26	kΩ

*0dBm = 1mW (600Ω) = 774.6mVrms

Package Dimensions

unit : mm

3107B

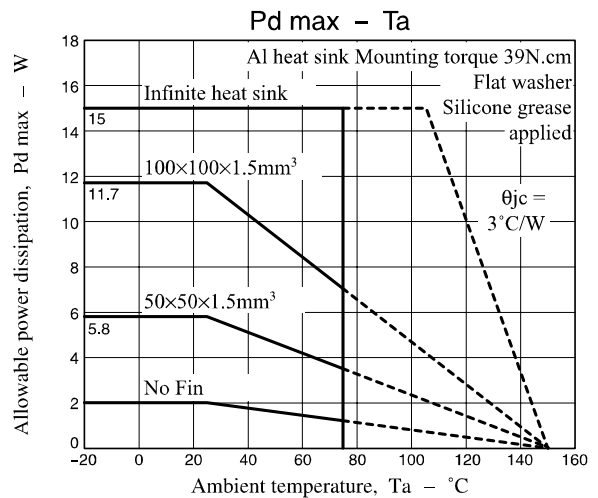
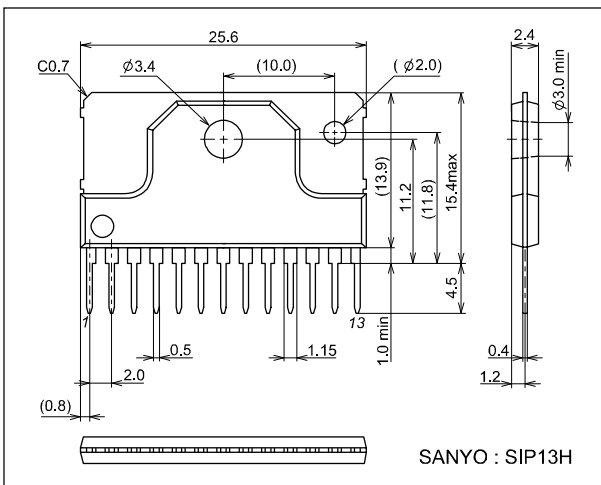

LA42352

Block Diagram

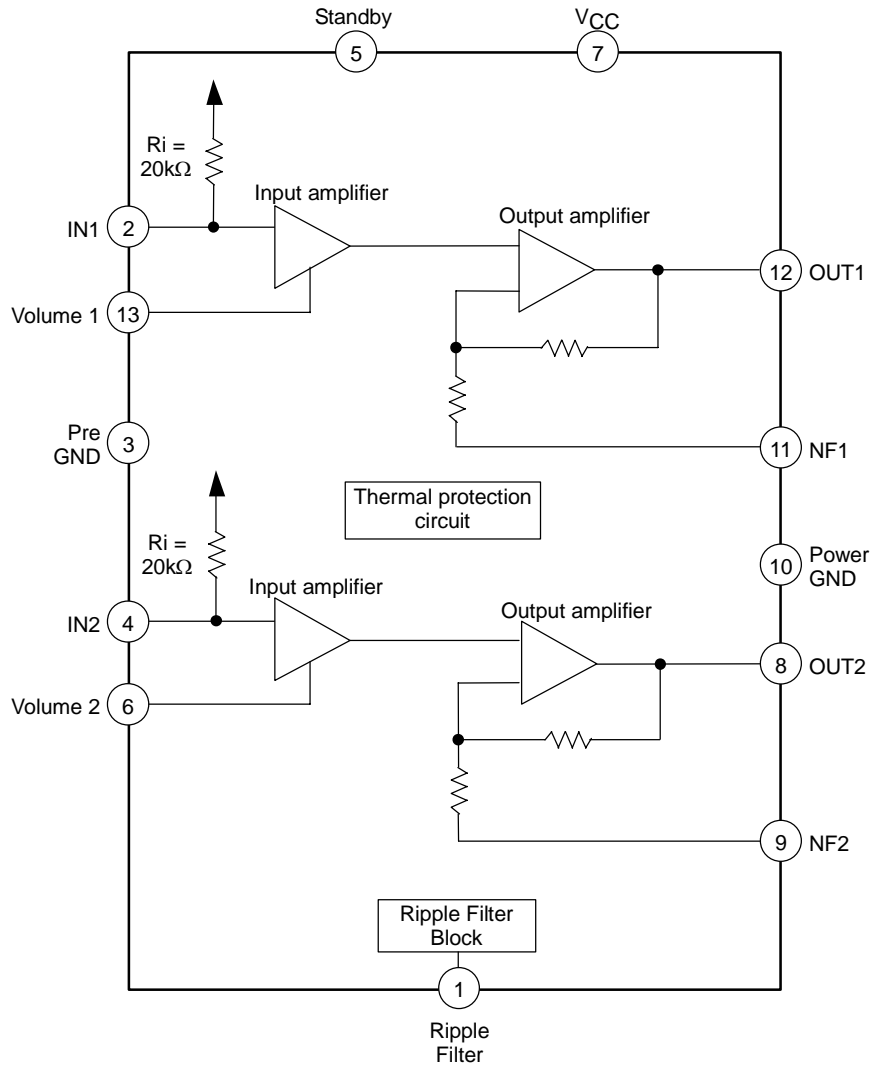

Sample Application Circuit

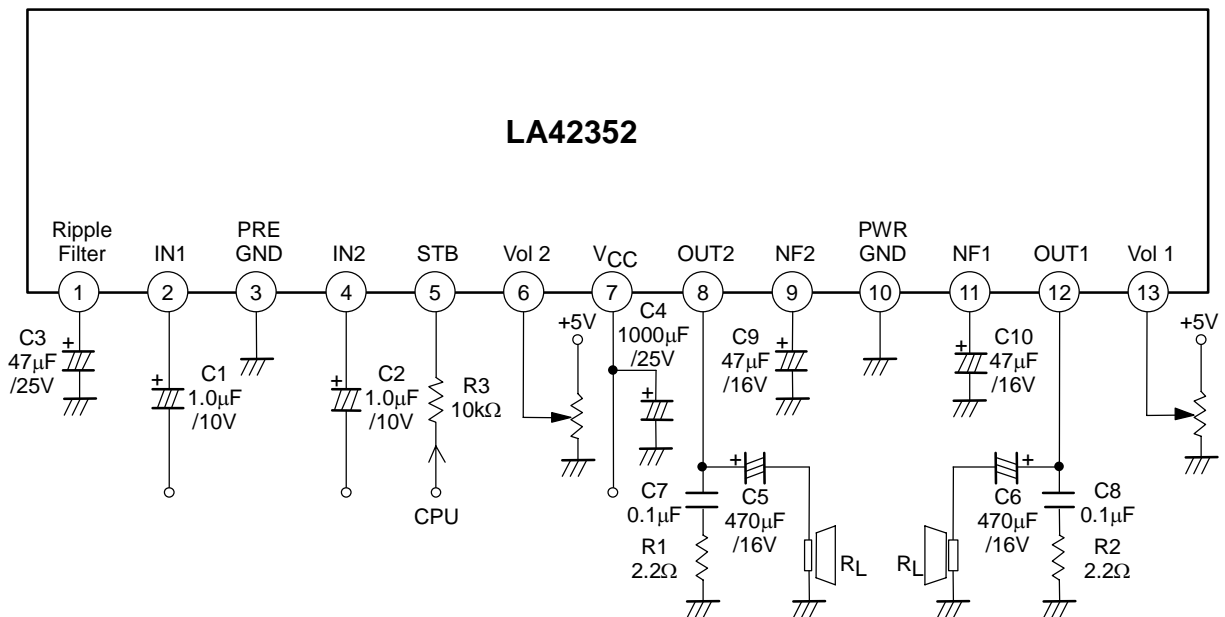

LA42352

Pin Descriptions

Pin No	Symbol	Pin Voltage	Equivalent Circuit	Description
		$V_{CC} = 18V$		
1	RF	17.6		<ul style="list-style-type: none"> Ripple filter reference
2 4	IN1 IN2	4.4		<ul style="list-style-type: none"> Input pin
3	PRE_GND	0		<ul style="list-style-type: none"> Pre GND pin
5	STB	0 to 5V (Input voltage)		<ul style="list-style-type: none"> Standby pin The standby function is on when this pin at ground level
6 13	Vol 2 Vol 1	0 to 5V (Input voltage)		<ul style="list-style-type: none"> Control Volume
7	V_{CC}	18		<ul style="list-style-type: none"> Power supply

Continued on next page.

LA42352

Continued from preceding page.

Pin No	Symbol	Pin Voltage	Equivalent Circuit	Description
		$V_{CC} = 18V$		
8 12	OUT2 OUT1	8.9		<ul style="list-style-type: none"> • Output pin
9 10	NF2 NF1	8.8		<ul style="list-style-type: none"> • Negative feedback pin at Power amplifier • Connect NF capacitor
10	PWR_GND	0		<ul style="list-style-type: none"> • Power GND pin

Description of External parts

- C1, C2 : Input capacitors. A value of $1.0\mu F$ is recommended for capacitors. Note that the low-frequency area characteristics can be adjusted by changing f_L .
- C3 : Ripple filter capacitor. A value of $47\mu F$ is recommended for capacitors. Decreasing the capacitance value excessively or removing this capacitor causes ripple to occur. However, increasing the capacitance value does not always cause ripple to reduced. Decreasing the capacitance value makes the starting time earlier.
- C4 : Power capacitor.
- C5, C6 : Output capacitors. A value of $470\mu F$ is recommended for capacitors.
- C7, C8 : Oscillation blocking capacitor. Use a polyester film capacitor that is good in high frequency response and temperature characteristic.
- C9, C10 : Feedback capacitor. A value of $47\mu F$ is recommended for capacitors. Decreasing the capacitance value lowers the low frequency response. Increasing the capacitance value makes the starting time later.
- R1, R2 : Resistor connected in series with oscillation blocking capacitor. Prevents phase shift attributable to the oscillation blocking capacitor so that oscillation is hard to occur.
- R3 : Standby switch current limiting resistor. A value of $10k\Omega$ is recommended for resistance (when the applied voltage for the standby switch is 3V to 10V). This resistor cannot be removed.

Features of IC Inside and Usage Note

Standby function

- Pin 5 is the standby switch pin. The amplifier is turned on by applying approximately 3V or more to this pin through an external resistor (R3).
- If voltage in excess of 10V is to be applied to the standby switch, calculate the value of R3 using the following formula so that the current flowing into pin 5 is 500μA or less:

$$R3 = \frac{(\text{Applied voltage} - 2V_{BE} (\approx 1.4V))}{500\mu A} - 15k\Omega$$

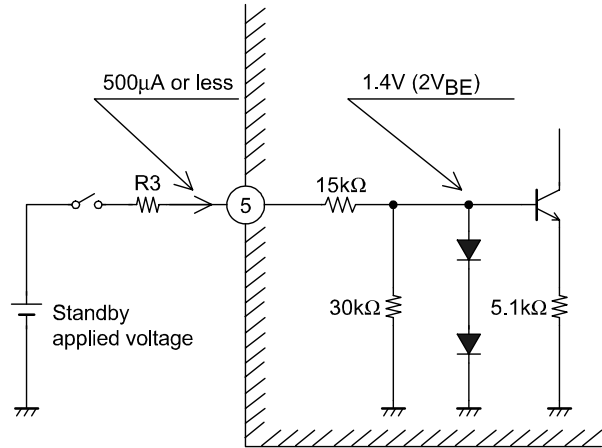

Protector

- In order to prevent damage or degradation which may be caused by abnormally heated IC, the LA42352 has a thermal shutdown protector. Accordingly, if the IC junction temperature (T_j) climbs to around 160°C due to inadequate heat dissipation, the thermal shutdown protector will operate to control the output gradually into attenuation.

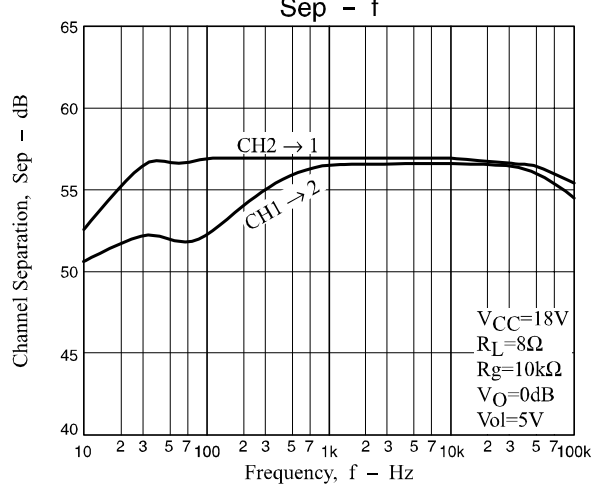
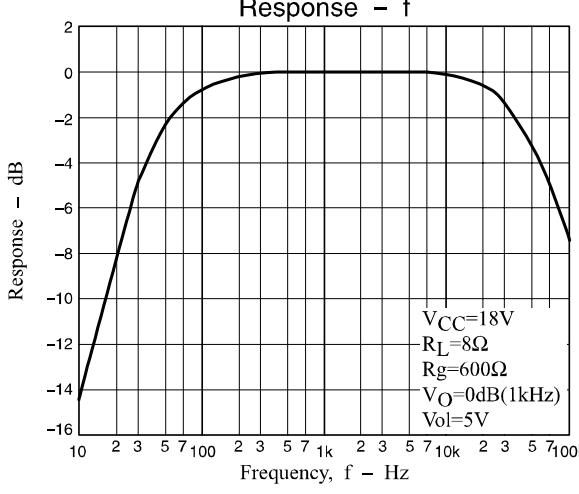
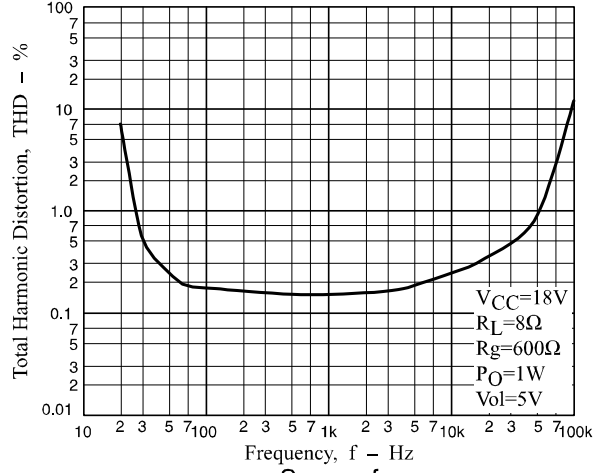
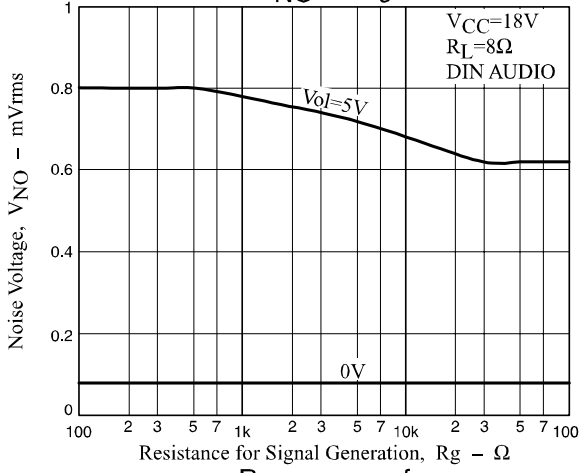
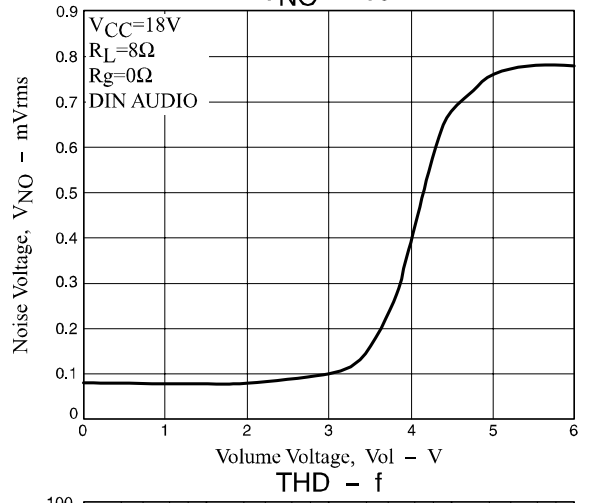
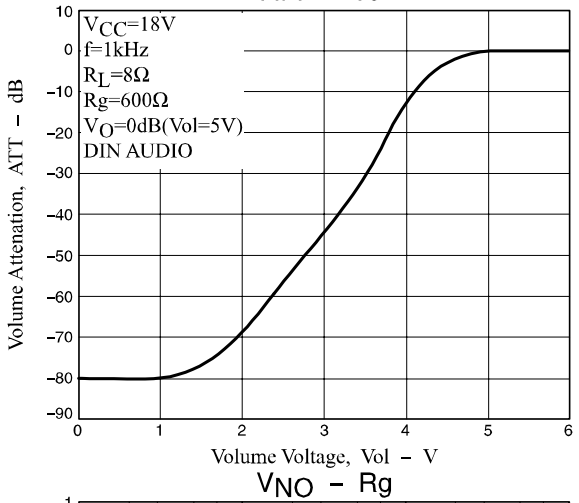
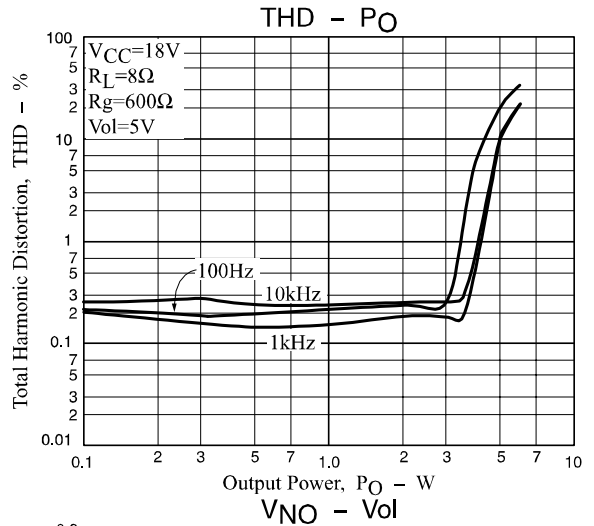
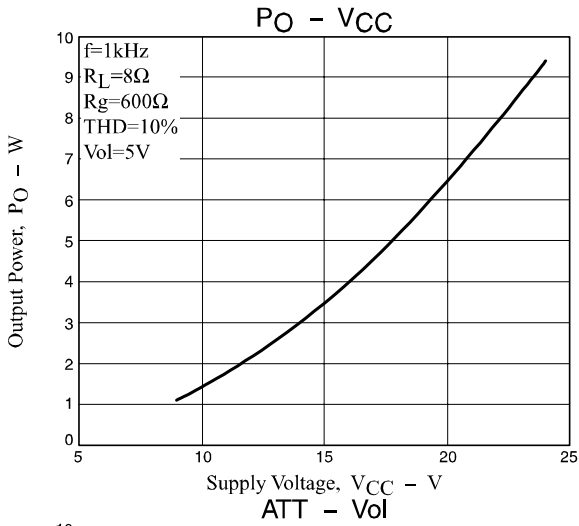

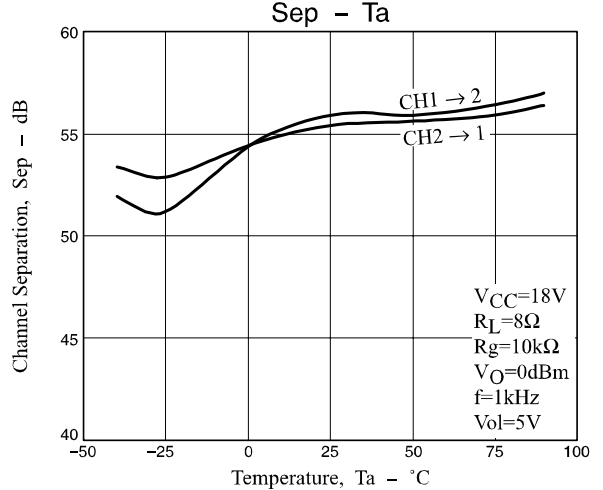
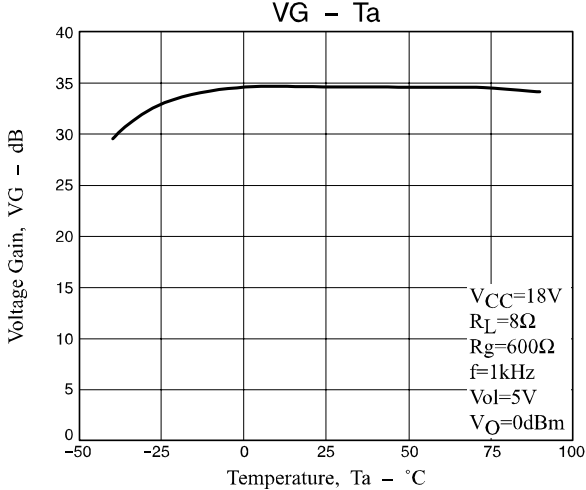
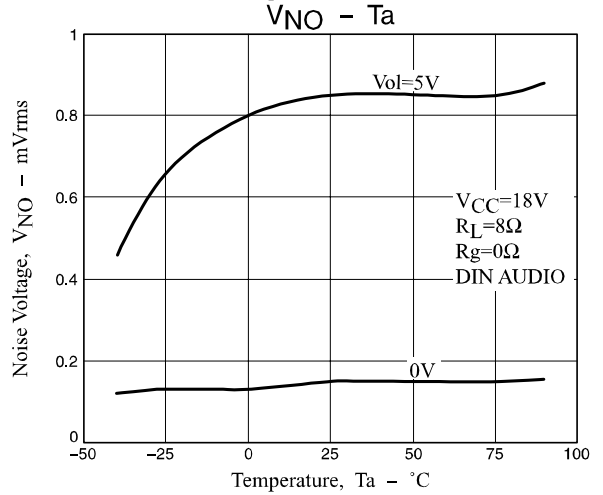
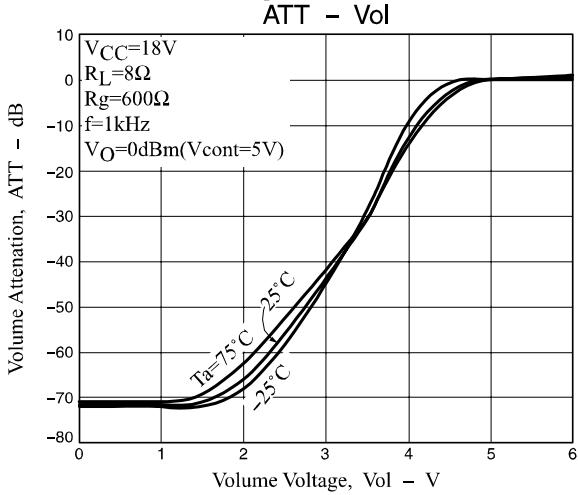
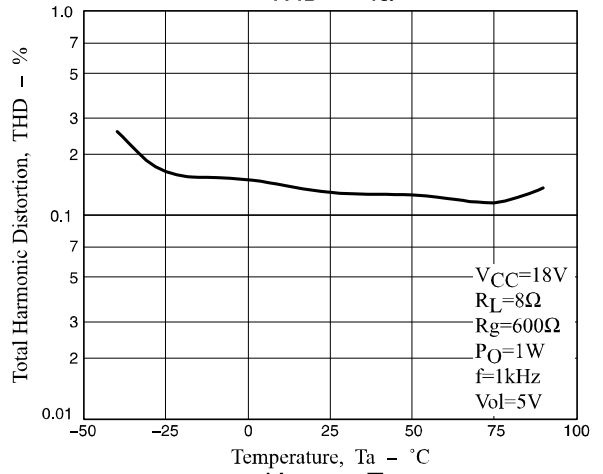
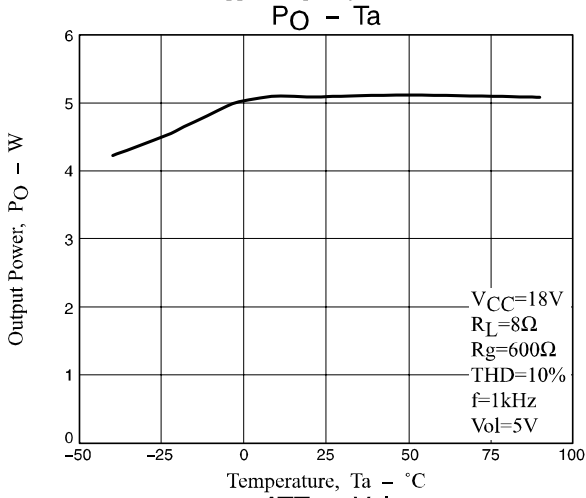
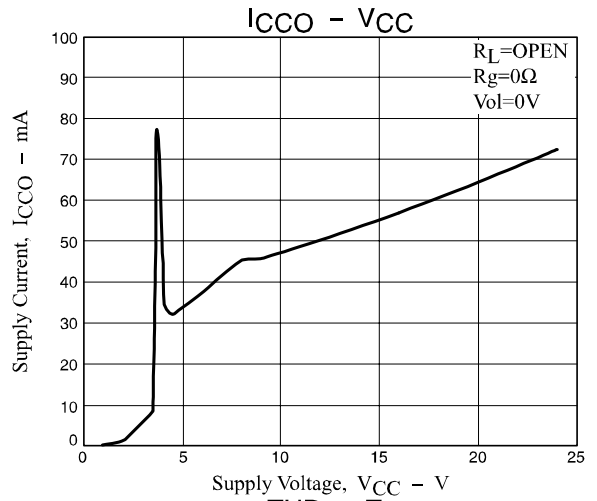
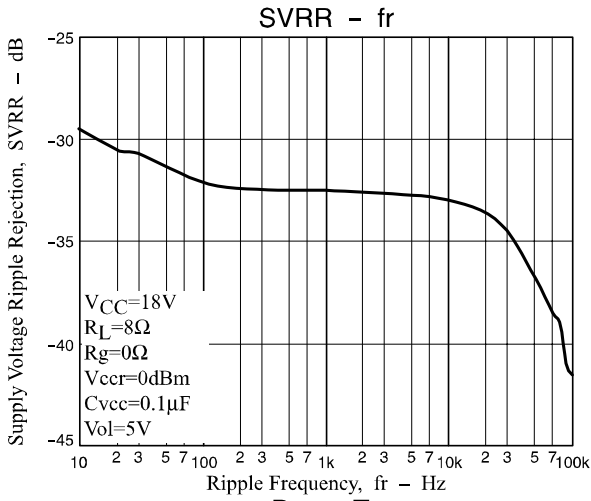

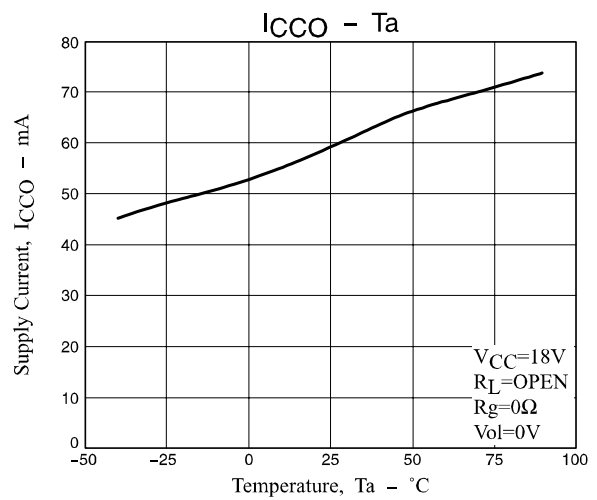
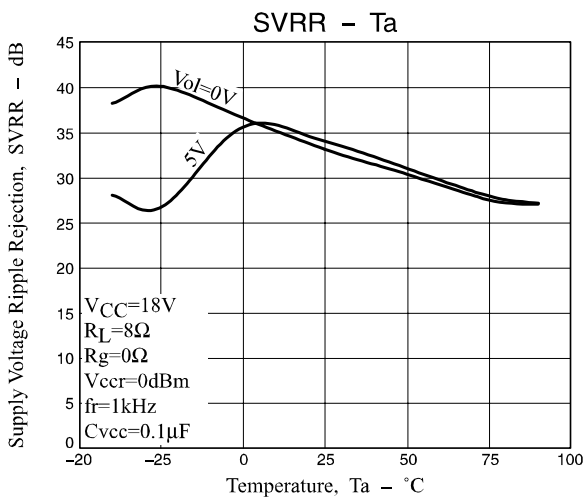

- Specifications of any and all SANYO products described or contained herein stipulate the performance, characteristics, and functions of the described products in the independent state, and are not guarantees of the performance, characteristics, and functions of the described products as mounted in the customer's products or equipment. To verify symptoms and states that cannot be evaluated in an independent device, the customer should always evaluate and test devices mounted in the customer's products or equipment.
- SANYO Electric Co., Ltd. strives to supply high-quality high-reliability products. However, any and all semiconductor products fail with some probability. It is possible that these probabilistic failures could give rise to accidents or events that could endanger human lives, that could give rise to smoke or fire, or that could cause damage to other property. When designing equipment, adopt safety measures so that these kinds of accidents or events cannot occur. Such measures include but are not limited to protective circuits and error prevention circuits for safe design, redundant design, and structural design.
- In the event that any or all SANYO products (including technical data, services) described or contained herein are controlled under any of applicable local export control laws and regulations, such products must not be exported without obtaining the export license from the authorities concerned in accordance with the above law.
- No part of this publication may be reproduced or transmitted in any form or by any means, electronic or mechanical, including photocopying and recording, or any information storage or retrieval system, or otherwise, without the prior written permission of SANYO Electric Co., Ltd.
- Any and all information described or contained herein are subject to change without notice due to product/technology improvement, etc. When designing equipment, refer to the "Delivery Specification" for the SANYO product that you intend to use.
- Information (including circuit diagrams and circuit parameters) herein is for example only; it is not guaranteed for volume production. SANYO believes information herein is accurate and reliable, but no guarantees are made or implied regarding its use or any infringements of intellectual property rights or other rights of third parties.

This catalog provides information as of August, 2005. Specifications and information herein are subject to change without notice.