

Features

- Minimum output power - 50 W
- Dual power supply - single channel
- Thick film hybrid
- Load shorting protector

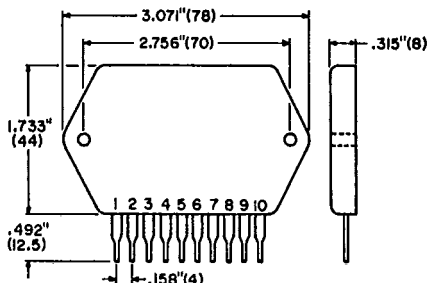

Absolute Maximum Ratings

Characteristic	Symbol	Rating	Unit
Supply Voltage	V_{CC}	± 50	V
Collector Current	I_C	7	A
Thermal Coefficient	θ_{j-c} ($T_c = 25^\circ\text{C}$)	1.7	$^\circ\text{C/W}$
Operating Case Temperature	T_c	85	$^\circ\text{C}$
Storage Temperature	T_{stg}	-30 to +100	$^\circ\text{C}$

Operational Characteristics ($T_A = 25^\circ\text{C}$, $V_{CC} = \pm 35\text{ V}$, $R_L = 8\ \Omega$, $R_g = 600\ \Omega$, $V_G = 26.4\ \text{dB}$)

Characteristic	Symbol	Test Condition	Min	Typ	Max	Unit
Quiescent Current	I_{CCO}	$V_{CC} = \pm 42\text{ V}$		50	100	mA
Output Power	$P_O(1)$	THD = 0.2%, $f = 20\text{ to }20\text{ kHz}$	50			W
	$P_O(2)$	THD = 0.2%, $f = 1\text{ kHz}$		60		
	$P_O(3)$	THD = 0.2%, $V_{CC} = \pm 42\text{ V}$, $f = 1\text{ kHz}$		70		
Distortion	THD(1)	$P_O = 1\text{ to }50\text{ W}$, $f = 20\text{ to }20\text{ kHz}$			0.2	%
	THD(2)	$P_O = 1\text{ W}$, $f = 1\text{ kHz}$		0.03		
Frequency Response	f	$P_O = 1\text{ W}$, $+0\text{ dB}$ -1 dB		10 to 100 K		Hz
Input Resistance	r_i	$P_O = 1\text{ W}$, $f = 1\text{ kHz}$		52 K		Ω
Output Noise Voltage	V_{NO}	$V_{CC} = \pm 42\text{ V}$, $R_g = 10\text{ k}\Omega$		0.3	0.5	mVrms
Noise Voltage	V_N	$V_{CC} = \pm 42\text{ V}$	-70		+70	mV

Equivalent Circuit

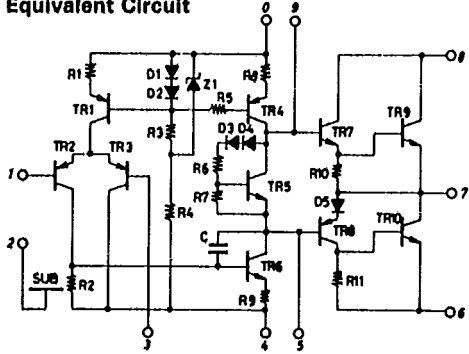

PC Board

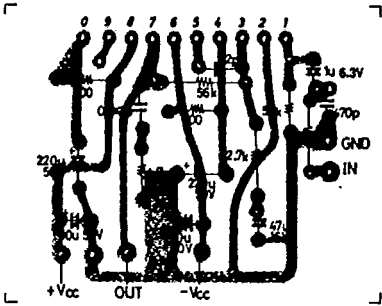

Application

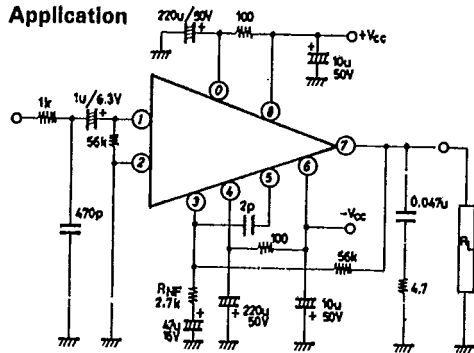

Typical Characteristics

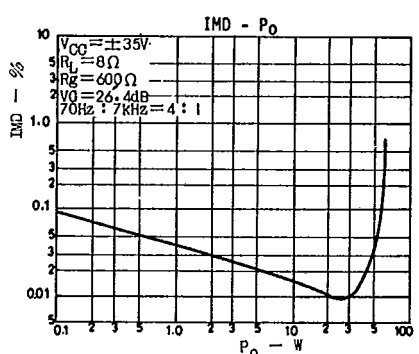
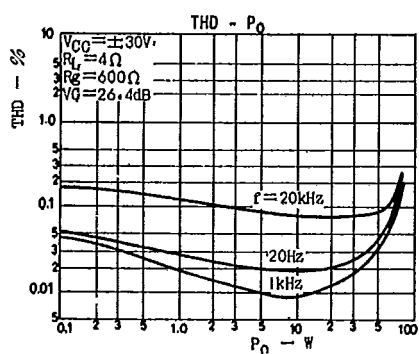
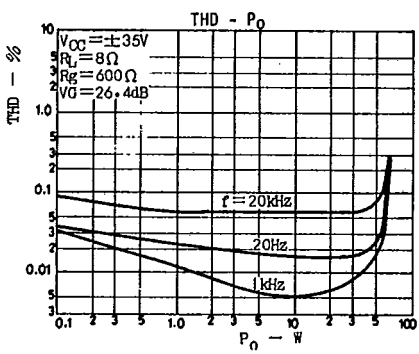
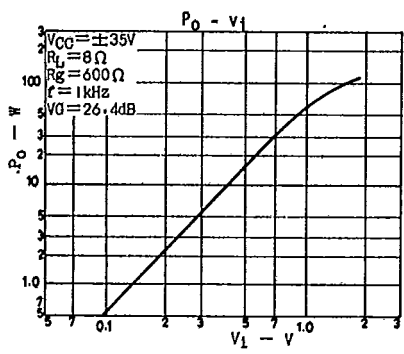
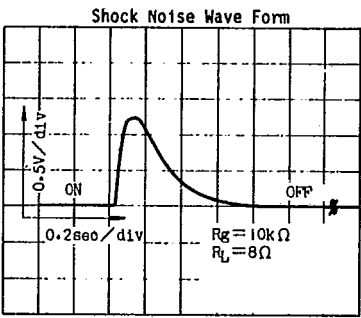

Typical Characteristics (Cont.)

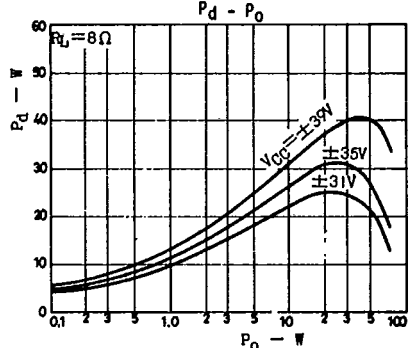
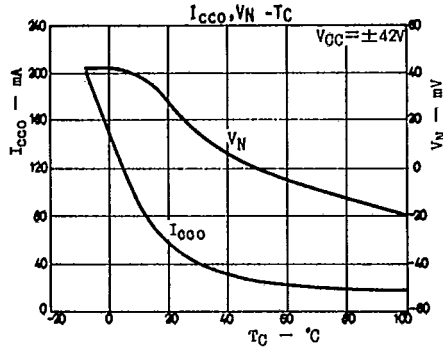
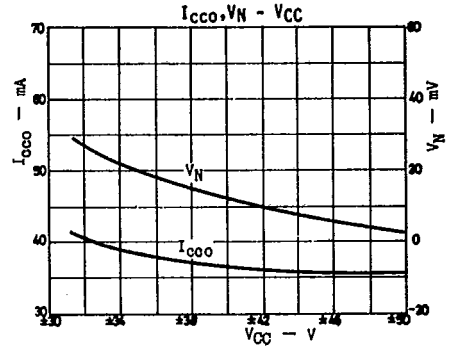
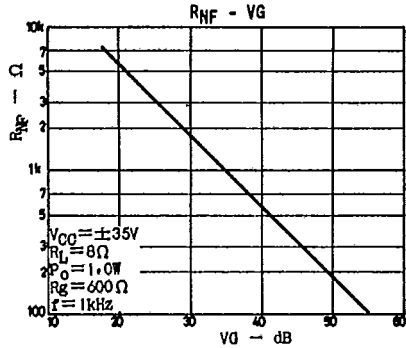
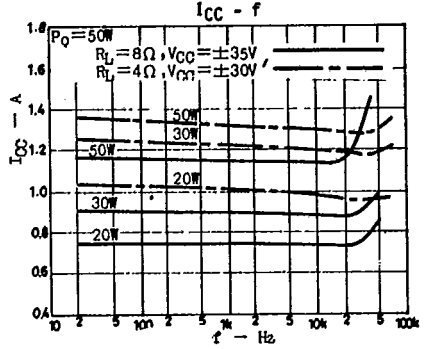
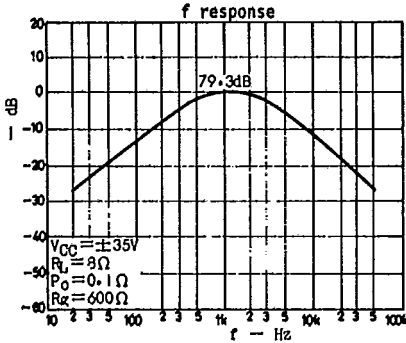
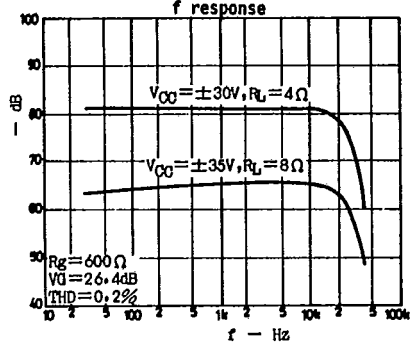
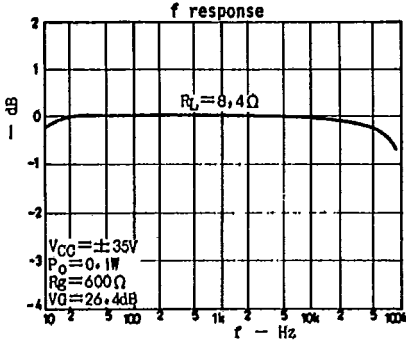

Typical Characteristics (Cont.)

